

**Bestellinformationen
Ordering information****Bestellbeispiel
Ordering example****35B25-1750-000 -D190,50**

(BTA-Gewinde 1-gängig für BR-Ø142, mit Kunststoff-Führungsleisten, Schneiden Typ 34, Bohr-Ø190,50)
 (BTA-Thread 1-start for drill tube 142, with plastic guide pads, inserts Type 34, drilling diameter 190,50)

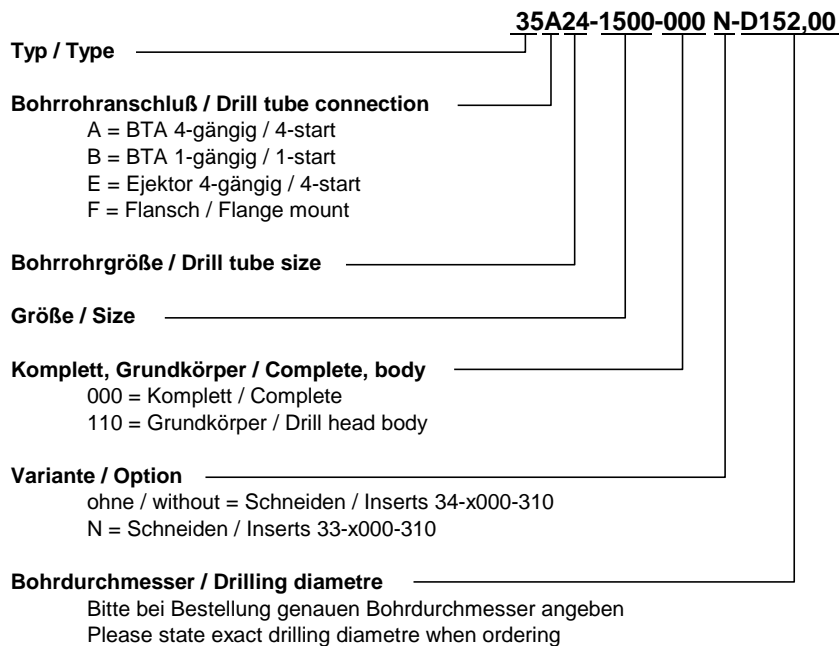

35A27-2000-000 N-D205,00

(BTA-Gewinde 4-gängig für BR-Ø166, Schneiden Typ 33, Bohr-Ø205,00)
 (BTA-Thread 4-start for drill tube 166, inserts Type 33, drilling diameter 205,00)

- Bitte beachten Sie unsere Sicherheitshinweise unter www.botek.de.
- Es gelten unsere allgemeinen Geschäftsbedingungen, welche wir als bekannt voraussetzen.
- Wir behalten uns Änderungen jeder Art vor, die aus technischer Weiterentwicklung resultieren. Diese können grundsätzlich nicht als Reklamation anerkannt werden.
- Änderungen, Druckfehler und Irrtum vorbehalten.
- Please note our safety pointers at www.botek.de.
- Our General Standard Terms and Conditions, which we assume as known, apply.
- We reserve the right to make modifications in the interests of technical improvement. Such modifications cannot, in principle, be accepted as justifiable reasons for complaint.
- Subject to change. The manufacturer accepts no responsibility for misprints and other errors.

Aufbohrkopf Typ 35A System BTA; Anschlussgewinde 4-gängig außen
Counterboring head Typ 35A System BTA; 4-start connection thread external

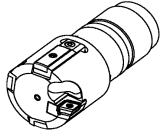
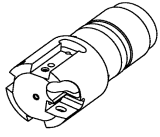
Verstellung mit Einstellkeil
Adjustment using adjusting wedge

Bohrrohrgröße Drill tube size	Bohrrohr ø Da Drill tube outer dia Da [mm]	Bohrbereich Drilling range von bis from to	Verstellbereich Adjustment range [mm]	Aufbohrkopf Counterboring head		
				Komplett Complete	Grundkörper Drill head body	Schlüssel Wrench
14	51	61,00 - 66,99	6			
15	56	67,00 - 73,99	7	35A14-0610-000	35A14-0610-110	34-1500-910
17	62	74,00 - 80,99	7	35A15-0670-000	35A15-0670-110	
18	68	81,00 - 89,99	9	35A17-0740-000	35A17-0740-110	34-1800-910
19	75	90,00 - 98,99	9	35A18-0810-000	35A18-0810-110	
20	82	99,00 - 110,99	12	35A19-0900-000	35A19-0900-110	
21	94	111,00 - 122,99	12	35A20-0990-000	35A20-0990-110	34-2000-910
22	106	123,00 - 134,99	12	35A21-1110-000	35A21-1110-110	
22	106	123,00 - 134,99	12	35A22-1230-000	35A22-1230-110	
23	118	135,00 - 148,99	14	35A23-1350-000	35A23-1350-110	

Verstellung mit Einstellring
Adjustment using adjusting disc

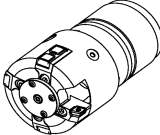
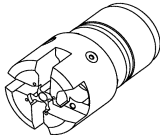
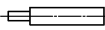
Bohrrohrgröße Drill tube size	Bohrrohr ø Da Drill tube outer dia Da [mm]	Bohrbereich Drilling range von bis from to	Verstellbereich Adjustment range [mm]	Aufbohrkopf Counterboring head					
				Komplett Complete	Grundkörper Drill head body	Schlüssel Wrench	Spänerohr Chip Tube	1 x Spänerohr Anschlussstück 1 x Chip Tube connection piece	3 x Schraube 3 x Screw
24	130	149,00 - 173,99	25				-	-	-
26	154	174,00 - 198,99		35A24-1500-000	35A24-1500-110	34-2400-910	2"	34-2500-190	M10 x 16 DIN 914
27	166	199,00 - 223,99		35A26-1750-000	35A26-1750-110		2,5"	34-2800-190	
				35A27-2000-000	35A27-2000-110				

Verstellung mit Einstellkeil

Adjustment using adjusting wedge

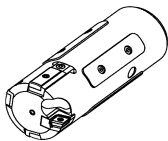
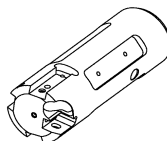
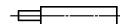
Bohrrohrgröße Drill tube size	Bohrrohr ø Da Drill tube outer dia Da [mm]	Bohrbereich Drilling range von bis from to	Verstellbereich Adjustment range [mm]	Aufbohrkopf Counterboring head		
				Komplett Complete	Grundkörper Drill head body	Schlüssel Wrench
14	51	61,00 - 66,99	6			
15	56	67,00 - 73,99	7	35B15-0670-000	35B15-0670-110	34-1500-910
17	62	74,00 - 80,99	7	35B17-0740-000	35B17-0740-110	
18	68	81,00 - 89,99	9	35B18-0810-000	35B18-0810-110	34-1800-910
19	75	90,00 - 98,99	9	35B19-0900-000	35B19-0900-110	
20	82	99,00 - 110,99	12	35B20-0990-000	35B20-0990-110	34-2000-910
21	94	111,00 - 122,99	12	35B21-1110-000	35B21-1110-110	
22	106	123,00 - 134,99	12	35B22-1230-000	35B22-1230-110	34-2000-910
23	118	135,00 - 148,99	14	35B23-1350-000	35B23-1350-110	

Verstellung mit Einstellring

Adjustment using adjusting disc

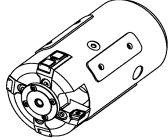
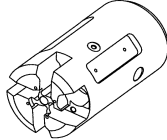
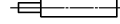
Bohrrohrgröße Drill tube size	Bohrrohr ø Da Drill tube outer dia Da [mm]	Bohrbereich Drilling range von bis from to	Verstellbereich Adjustment range [mm]	Aufbohrkopf Counterboring head					
				Komplett Complete	Grundkörper Drill head body	Schlüssel Wrench	Spänerohr Chip Tube	1 x Spänerohr Anschlussstück 1 x Chip Tube connection piece	3 x Schraube 3 x Screw
24	130	149,00 - 173,99	25				-	-	-
25	142	174,00 - 198,99		35B25-1750-000	35B25-1750-110	34-2400-910	2"	34-2500-190	M10 x 16 DIN 914
27	166	199,00 - 223,99		35B27-2000-000	35B27-2000-110				
29	190	224,00 - 248,99		35B29-2250-000	35B29-2250-110	34-3000-910	2,5"	34-2800-190	
31	214	249,00 - 273,99		35B31-2500-000	35B31-2500-110				
33	238	274,00 - 298,99		35B33-2750-000	35B33-2750-110				
34	250	299,00 - 348,99	50	35B34-3000-000	35B34-3000-110	34-3000-910	2,5"	34-3500-190	
39	310	349,00 - 398,99		35B39-3500-000	35B39-3500-110				
43	358	399,00 - 448,99		35B43-4000-000	35B43-4000-110				
47	406	449,00 - 498,99		35B47-4500-000	35B47-4500-110	34-3000-910	2,5"	34-3500-190	
				35B47-4500-000	35B47-4500-110				



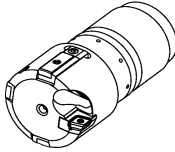
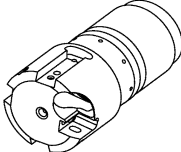
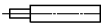



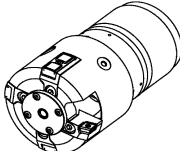
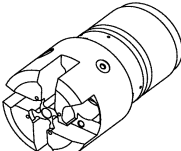
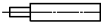

Verstellung mit Einstellkeil
Adjustment using adjusting wedge

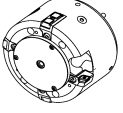
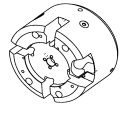









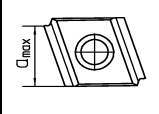

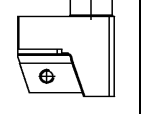

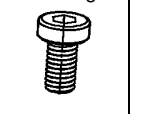
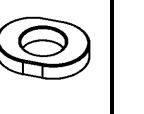
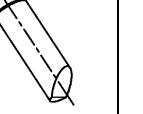
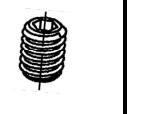
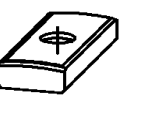
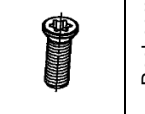
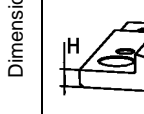
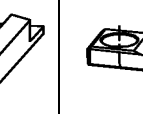
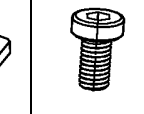
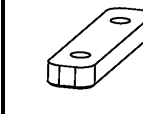
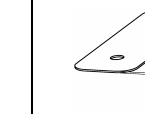
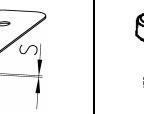
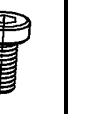

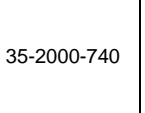
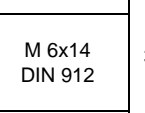
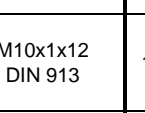
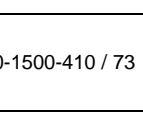
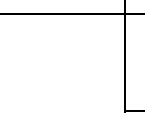
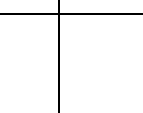
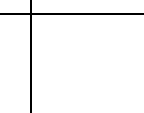

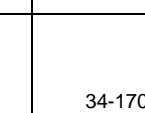
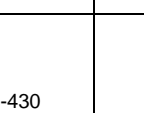
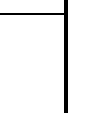
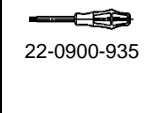

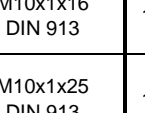
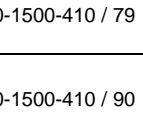
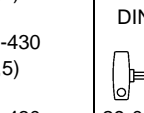
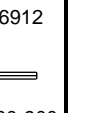
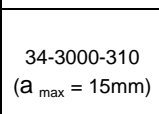

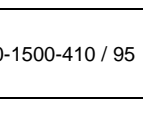
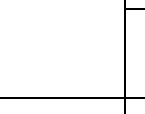

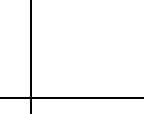

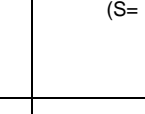
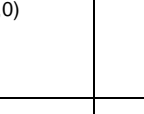
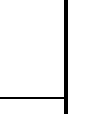
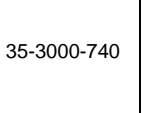
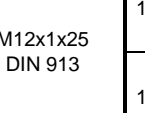
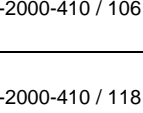
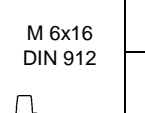
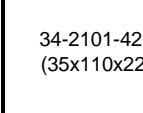
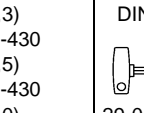
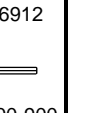
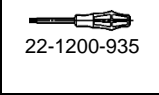

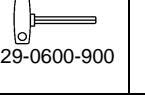
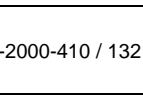
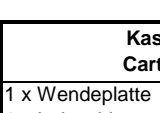
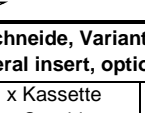











Bohrrohrgröße Drill tube size	Bohrrohr ø Da Drill tube outer dia Da [mm]	Bohrbereich Drilling range von bis from to	Verstellbereich Adjustment range [mm]	Aufbohrkopf Counterboring head		
				Komplett Complete	Grundkörper Drill head body	Schlüssel Wrench
14	55,5	61,00 - 66,99	6			
17	62	67,00 - 73,99	7	35E14-0610-000	35E17-0670-110	
18	68	74,00 - 80,99	7	35E18-0740-000	35E18-0740-110	34-1800-910
19	75	81,00 - 89,99	9	35E19-0810-000	35E19-0810-110	
20	82	90,00 - 98,99	9	35E20-0900-000	35E20-0900-110	34-2000-910
21	94	99,00 - 110,99	12	35E21-0990-000	35E21-0990-110	
22	106	111,00 - 122,99	12	35E22-1110-000	35E22-1110-110	34-2000-910
23	118	123,00 - 134,99	12	35E23-1230-000	35E23-1230-110	
24	130	135,00 - 148,99	14	35E24-1350-000	35E24-1350-110	

Verstellung mit Einstellring
Adjustment using adjusting disc

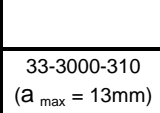
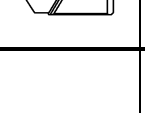



Bohrrohrgröße Drill tube size	Bohrrohr ø Da Drill tube outer dia Da [mm]	Bohrbereich Drilling range von bis from to	Verstellbereich Adjustment range [mm]	Aufbohrkopf Counterboring head		
				Komplett Complete	Grundkörper Drill head body	Schlüssel Wrench
24	130	149,00 - 173,99	25			
27	166	174,00 - 198,99		35E24-1500-000	35E24-1500-110	
				35E27-1750-000	35E27-1750-110	





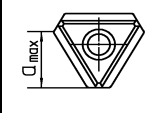

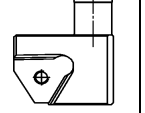

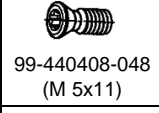
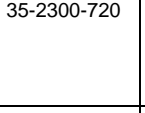
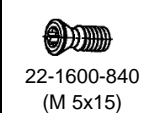
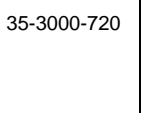
Verstellung mit Einstellring
Adjustment using adjusting disc

Bohrrohrgröße Drill tube size	Bohrrohr ø Da Drill tube outer dia Da [mm]	Bohrbereich Drilling range von bis from to	Verstellbereich Adjustment range [mm]	Aufbohrkopf Counterboring head									
				Komplett Complete 	Grundkörper Drill head body 	Schlüssel Wrench 	Spänerohr Chip Tube 	1 x Spänerohr Anschlussstück 1 x Chip Tube connection piece 	3x Schraube 3x Screw 	4x Schraube 4x Screw 	2x Mitnehmerstein 2x Driver 	2x Schraube 2x Screw 	3x Gewindestift 3x Threaded pin 
29	190	224,00 - 248,99	25	35F29-2250-000	35F29-2250-110	34-3000-910	2,5"	34-2800-190	M10 x 16 DIN 914	M 10x90 DIN 912	48-2900-160	M 6x30 DIN 912	M 8x30 DIN 915
31	214	249,00 - 273,99		35F31-2500-000	35F31-2500-110								
33	238	274,00 - 298,99		35F33-2750-000	35F33-2750-110								
34	250	299,00 - 348,99	50	35F34-3000-000	35F34-3000-110	34-3000-910	2,5"	34-3500-190	M10 x 16 DIN 914	M 12x90 DIN 912	48-2900-160	M 6x30 DIN 912	M 10x30 DIN 915
39	310	349,00 - 398,99		35F39-3500-000	35F39-3500-110								
43	358	399,00 - 448,99		35F43-4000-000	35F43-4000-110								
47	406	449,00 - 498,99		35F47-4500-000	35F47-4500-110								

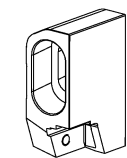

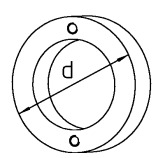
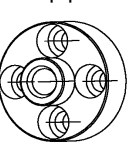
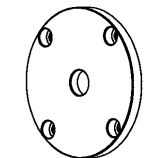

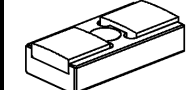
Bohrbereich Drilling range von bis from to	Verstellbereich Adjustment range [mm]	Kassette mit Außenschneide, Standard Cartridge with peripheral insert, Standard					Einstellkeil Adjusting wedge		HM-Führungsleisten Carbide guide pads					Kunststoff-Führungsleisten (nur Typ 35B) Plastic guide pads (Type 35B only)				
		1 x Wendeplatte 1 x Indexable insert 	1 x Unterlage 1 x Shim 	1 x Kassette 1 x Cartridge 	1 x Einstellplatte 1 x Stop plate 	1 x Schraube Kassette 1 x Screw Cartridge 	1 x Unterleg- scheibe 1 x Shim 	1 x Einstellkeil 1 x Adjusting wedge 	1 x Gewindestift 1 x Screw 	3 x Führungsleiste 3 x Guide pad 	3 x Schraube 3 x Screw 	Rechenmaß X Dimension X 	3 x Kassette 3 x Cartridge 	3 x Anschlag 3 x Stop pin 	6 x Schraube 6 x Screw 	4 x Führungsleiste 4 x Guide pad 	4 x Unterlage 4 x Shim 	8 x Schraube 8 x Screw 
61,00 - 66,99	6																	
67,00 - 73,99	7	34-2000-310 (a _{max} = 12mm) 		01-2400-610-S.. 	M 6x12 DIN 6912 		35-0610-510	M10x12 DIN 913 	10-1200-410 / 59 	22-1500-820 (M 3,5x14) 	53	10-1200-400 / .. 	10-1200-150 	M 4x14 DIN 6912 	34-1400-422 (20x72x12) 	34-1403-432 (S= 0,3) 	M 4x8 DIN 6912 	
74,00 - 80,99	7	22-0900-831 (M 4x12) 	34-2000-710	35-2000-740 	21-0200-860 (M 2,5x4,7) 	35-2000-872		M10x12 DIN 913 	10-1500-410 / 73 		64						34-1703-430 (S= 0,3) 	M 5x12 DIN 6912 
81,00 - 89,99	9	22-0900-935 			22-0600-925 		35-0740-510	M10x16 DIN 913 	10-1500-410 / 79 	22-1600-840 (M 5x15) 	71	10-1500-400 / .. 	10-1500-150 	M 5x16 DIN 6912 	34-1701-420 (25x100x20) 	34-1705-430 (S= 0,5) 	M 5x12 DIN 6912 	
90,00 - 98,99	9				22-0600-925 			M10x25 DIN 913 	10-1500-410 / 90 	22-1200-935 	80			29-0400-900 		34-1710-430 (S= 1,0) 	29-0400-900 	
99,00 - 110,99	12	34-3000-310 (a _{max} = 15mm) 		01-3750-610-S.. 	M 8x16 DIN 912 		35-0990-510		10-1500-410 / 95 		89							
111,00 - 122,99	12	22-1200-831 (M 5x14,2) 	34-3000-710	35-3000-740 	21-0600-860 (M 3x6,7) 	35-3000-872		M12x25 DIN 913 	10-2000-410 / 106 	M 6x16 DIN 912 	99						34-2103-430 (S= 0,3) 	M 5x16 DIN 6912 
123,00 - 134,99	12				M 8x20 DIN 912 		35-1230-510		10-2000-410 / 118 	29-0500-900 	111	10-2000-400 / .. 	10-2000-150 	M 6x20 DIN 6912 	34-2101-420 (35x110x22) 	34-2105-430 (S= 0,5) 	29-0400-900 	
135,00 - 148,99	14	22-1200-935 			22-0600-935 				10-2000-410 / 132 		123			29-0500-900 	34-2301-420 (40x135x28) 	34-2303-430 (S= 0,3) 34-2305-430 (S= 0,5) 34-2310-430 (S= 1,0) 	M 6x16 DIN 6912 	

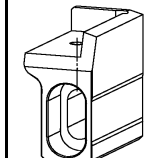
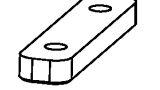
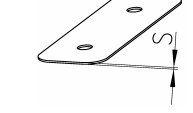
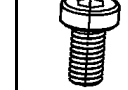



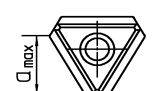

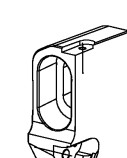



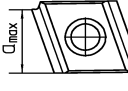
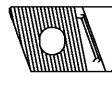
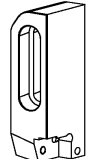

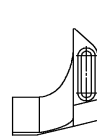
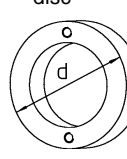
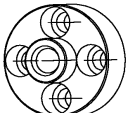
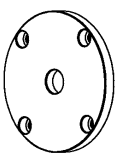

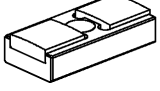

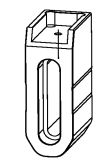
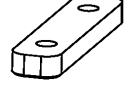
H = (Bohrdurchmesser - X) / 2
H = (Drilling dia - X) / 2

Bohrbereich Drilling range von bis from to	Verstellbereich Adjustment range [mm]	Kassette mit Außenschneide, Variante N Cartridge with peripheral insert, option N			
		1 x Wendeplatte 1 x Indexable insert 	1 x Unterlage 1 x Shim 	1 x Kassette 1 x Cartridge 	1 x Einstellplatte 1 x Stop plate 
61,00 - 98,99		33-3000-310 (a _{max} = 13mm) 	-	35-2300-720 	-
99,00 - 148,99		22-1600-840 (M 5x15) 	-	35-3000-720 	-







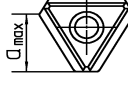

Bohrbereich Drilling range von bis from to	Verstellbereich Adjustment range [mm]	Kassette mit Außenschneide, Standard Cartridge with peripheral insert, Standard				Einstellring Adjusting disc				HM-Führungsleisten Carbide guide pads			4 x Unterleg- scheibe 4 x Shim	Kunststoff-Führungsleisten (nur Typ 35B) Plastic guide pads (Type 35B only)							
		1 x Wendeplatte 1 x Indexable insert 	1 x Unterlage 1 x Shim 	1 x Kassette 1 x Cartridge 	1 x Einstellplatte 1 x Stop plate 	1 x Einstellring 1 x Adjusting disc 	1 x Anschlag- scheibe 1 x Stop pin 	1 x Deckscheibe 1 x Cover disc 	Schraube Screw 	3 x Führungsleiste 3 x Guide pad 	3 x Schraube 3 x Screw 	3 x Kassette 3 x Cartridge 		4 x Führungsleiste 4 x Guide pad 	4 x Unterlage 4 x Shim 	Schraube Screw 					
149,00 - 173,99	25	34-3000-310 (a _{max} = 15mm)	34-3000-710	33-3000-740	01-3750-610-S..	33-1500-520	33-1500-530	35-1500-540	(4x) M 6x12 DIN 912	10-2500-410 / 150	33-2500-400	33-3000-872	34-2301-420 (40x135x28)	34-2303-430 (S= 0,3) 34-2305-430 (S= 0,5) 34-2310-430 (S= 1,0)	(8x) M 6x16 DIN 6912						
174,00 - 198,99							33-1500-850 (M8x25)	35-1750-540	29-0500-900	10-2500-410 / 170			33-2000-540	(3x) M 6x16 DIN 912	10-2500-410 / 190	M 6x16 DIN 912	M 10x65 DIN 912	99-363012-082 (60x170x28)	99-362825-081 (S= 0,5) 99-362820-081 (S= 1,0)	(12x) M 6x16 DIN 6912	
199,00 - 223,99							48-3000-820 (M 5x20)	M 10x50 DIN 912	21-0600-860 (M 3x6,7)	33-2000-530			33-2250-540	(4x) M 8x16 DIN 912	29-0500-900	10-2500-410 / 224	29-0500-900	SW 8 DIN 911	99-363012-082 (60x170x28)	99-362825-081 (S= 0,5) 99-362820-081 (S= 1,0)	29-0500-900
224,00 - 248,99							22-1200-935	SW 8 DIN 911	22-0600-935	33-2000-520			33-2500-540	(6x) M 6x16 DIN 912	29-0600-900	10-2500-410 / 236	29-0500-900	SW 8 DIN 911			
249,00 - 273,99													33-2750-540	(6x) M 6x16 DIN 912	29-0500-900	10-2500-410 / 265	29-0500-900	SW 8 DIN 911			
274,00 - 298,99																					

d = Bohrdurchmesser - 125
d = Drilling dia - 125

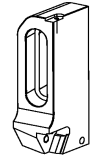
Bohrbereich Drilling range von bis from to	Verstellbereich Adjustment range [mm]	Kassette mit Außenschneide, Variante N Cartridge with peripheral insert, option N			
		1 x Wendeplatte 1 x Indexable insert 	1 x Unterlage 1 x Shim 	1 x Kassette 1 x Cartridge 	1 x Einstellplatte 1 x Stop plate 
149,00 - 298,99		33-3000-310 (a _{max} = 13mm)	33-3000-710	33-3000-720	01-3750-610-S..
		22-1600-840 (M 5x15)	22-0610-840 (M 2,5x5,9)	M 10x50 DIN 912	21-0600-860 (M 3x6,7)

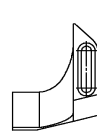
Bohrbereich Drilling range von bis from to	Verstellbereich Adjustment range [mm]	Kassette mit Außenschneide, Standard Cartridge with peripheral insert, Standard					Einstellung Adjusting disc				HM-Führungsleisten Carbide guide pads			4 x Unterleg- scheibe 4 x Shim	Kunststoff-Führungsleisten (nur Typ 35B) Plastic guide pads (Type 35B only)		
		1 x Wendeplatte 1 x Indexable insert 	1 x Unterlage 1 x Shim 	1 x Kassette 1 x Cartridge 	1 x Einstellplatte 1 x Stop plate 	1 x Spänegehäuse 1 x Chip housing 	1 x Einstellring 1 x Adjusting disc 	1 x Anschlag- scheibe 1 x Stop pin 	1 x Deckscheibe 1 x Cover disc 	4 x Schraube 4 x Screw 	3 x Führungsleiste 3 x Guide pad 	3 x Schraube 3 x Screw 	3 x Kassette 3 x Cartridge 		6 x Führungsleiste 6 x Guide pad 	6 x Unterlage 6 x Shim 	18 x Schraube 18 x Screw 
299,00 - 348,99	50	34-4000-310 (a _{max} = 19mm)	34-4000-710	33-4000-740	01-3750-610-S..	33-4000-745 		35-3000-540		10-3000-410 / 300		33-3000-400					
349,00 - 398,99		22-1500-831 (M 6x17,5)	M 4x16 DIN 912	(2x) M 10x50 DIN 912	21-0600-860 (M 3x6,7)	(1x) 33-4000-875 	33-2000-530 	35-3500-540	M 6x16 DIN 912	10-3000-410 / 335	M 6x16 DIN 912			34-3702-420 (50x210x50)	99-542416-013 (S= 0,5)	M 8x16 DIN 6912	
399,00 - 448,99		22-1500-935	29-0300-900	SW 8 DIN 911	22-0600-935	(2x) M 6x16 DIN 912 		35-4000-540	29-0500-900	10-3000-410 / 375	29-0500-900	(6x) M 10x65 DIN 912			99-542426-013 (S= 1,0)		
449,00 - 498,99						(1x) 5x14 DIN 6325 	29-0600-900	35-4500-540		10-3000-410 / 425		SW 8 DIN 911				29-0600-900	

d = Bohrdurchmesser - 240
d = Drilling dia - 240

Bohrbereich Drilling range von bis from to	Verstellbereich Adjustment range [mm]	Kassette mit Außenschneide, Variante N Cartridge with peripheral insert, option N				
		1 x Wendeplatte 1 x Indexable insert 	1 x Unterlage 1 x Shim 	1 x Kassette 1 x Cartridge 	1 x Einstellplatte 1 x Stop plate 	1 x Spänegehäuse 1 x Chip housing 
299,00 - 498,99		33-4000-310 (a _{max} = 17mm)	33-4000-710	33-4000-720	01-3750-610-S..	33-4000-745 
		22-1500-831 (M 6x17,5)	21-0600-860 (M 3x6,7)	(2x) M 10x50 DIN 912	21-0600-860 (M 3x6,7)	(1x) 33-4000-875 
						(2x) M 6x16 DIN 912 
						(1x) 5x14 DIN 6325 